

# 86484-2006

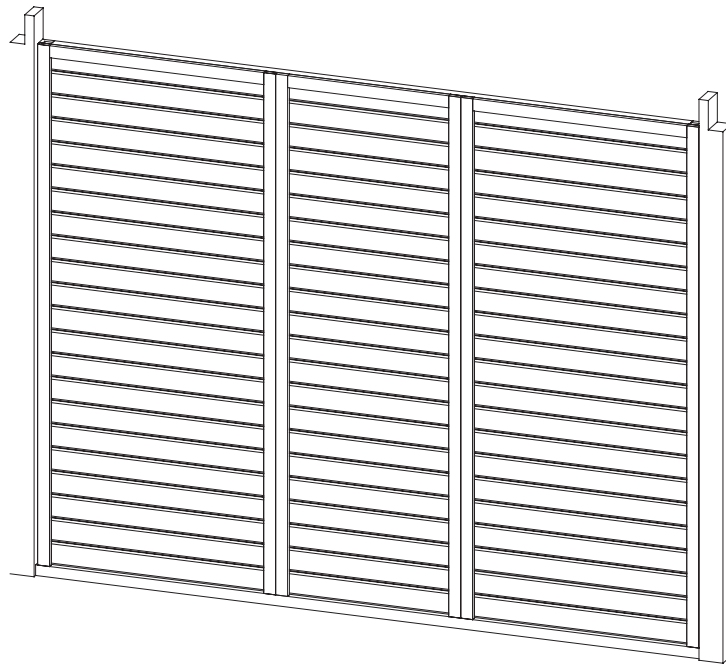



 **Aufbauanleitung**

 **Building Instructions**

 **Service-Hotline: +49 421 38693 33**



## 86484 Carport Rückwand 2,50 -2006

	
<p><b>Vergleichen Sie zuerst die Materialliste mit Ihrem Paketinhalt! Bitte haben Sie Verständnis, daß Beranstandungen nur im <u>nicht aufgebauten</u> Zustand bearbeitet werden können!</b></p>	<p><b>Using the bill of materials, please first check to be sure that all parts are contained in the package! Please note that claims can only be accepted for <u>constructions which have not been assembled!</u></b></p>

Pos. Pos.	Bezeichnung Description	L	B	H		Anzahl Quantity	Art.-Nr. Item Nr.
1	Wandelement	1950	895	18	vormontiert pre-assembled	2	41044
2	Wall unit	1950	695	18		1	41054
5	Winkelleiste Corner moulding	1950	38	45		4	40997
3	Innenversteifung Interior reinforcement	1905	95	18		2	15824
4	Unterleger Joist	1808	40	60		2	16413
6	Obere Blende Upper edging board	870	18	45		3	18129

Beschlagbeutel Fittings pouch		Maße Dimensions		Bezeichnung Description	Anzahl Quantity	Art.-Nr. Item Nr.	
Bild Illustration			4,5	80	Schrauben Screws	10	9204
			4	70		25	3689
			4	50		20	3688
			4	35		100	3687

Was wird mit was verbunden? What is to be joined to what?	Schraube Screw		Anzahl Quantity
Winkelleisten an Pfosten/ Ständer Corner moulding to posts/ pillars	4 x 50	je Leiste per strip	5
Innenversteifung an Wände Interior reinforcement to walls	4 x 35	je Versteifung per reinforcement	10
Unterleger an Wände Joist to walls	4 x 70	je Wandelement per wall unit	3
montierte Wand an Winkelleiste mounted wall to bracket moulding	4 x 35	je Leiste per strip	5
Obere Blenden an Wand Upper edging board to Wall	4 x 35		3
Winkelleiste an Wand Corner moulding to wall	4 x 35		3

Abb. fig.		
1-1 – 1-2	Montage des Wandelementes 1-2 Außenseite der Wand 1-1 Innenseite der Wand	Wall unit assembly 1-2 exterior side of wall 1-1 interior side of wall
2-1	Die Winkelleisten werden an die Pfosten geschraubt. Die Winkelleiste muss mindestens in einer Höhe von 4 cm vom Erdboden montiert werden, und gegebenenfalls oben eingekürzt werden.	The corner moulding is screwed to the posts. The corner moulding must be mounted a minimum of 4 cm above the ground and shortened at the top end if necessary.
2-2	Hier finden Sie einen Schnitt durch die aufzubauende Wand, wo Sie die Lage und Verschraubung der Einzelemente verdeutlicht wird,	A slit can be found in the wall which is being assembled. The position and screw connection of the individual elements is clarified here.
3-1 – 3-2	Die Wand wird an die Winkelleisten gehalten ( Oberkante Unterleger= Unterkante Winkelleiste. Setzen Sie die Wand ein und Verschrauben diese mit den Winkelleisten. 3-2 Außenseite der Wand 3-1 Innenseite der Wand	The wall units must be held to the corner moulding (upper edge joist = lower edge corner moulding). Insert the wall and screw it to the corner moulding. 3-2 exterior side of the wall 3-1 interior side of the wall
4-2	Um von Außen einen sauberen Abschluss des Wandelementes zu dem Rahmen des Carports zu erreichen, bringen Sie die oberen Blenden zwischen die Aufrechten Leisten der Wandelemente an. Diese müssen Sie sich den Gegebenheiten entsprechend zusägen.	In order to achieve a clean exterior finish between the wall units and the frame of the carport, attach the upper edging board between the vertical strips of the wall units. These may need to be sawed down to size.
4-1	Von Innen und oben übernimmt die Winkelleiste diese Aufgabe.	The corner moulding fulfils this function inside the construction.



Abb. 1-1



Abb. 1-2

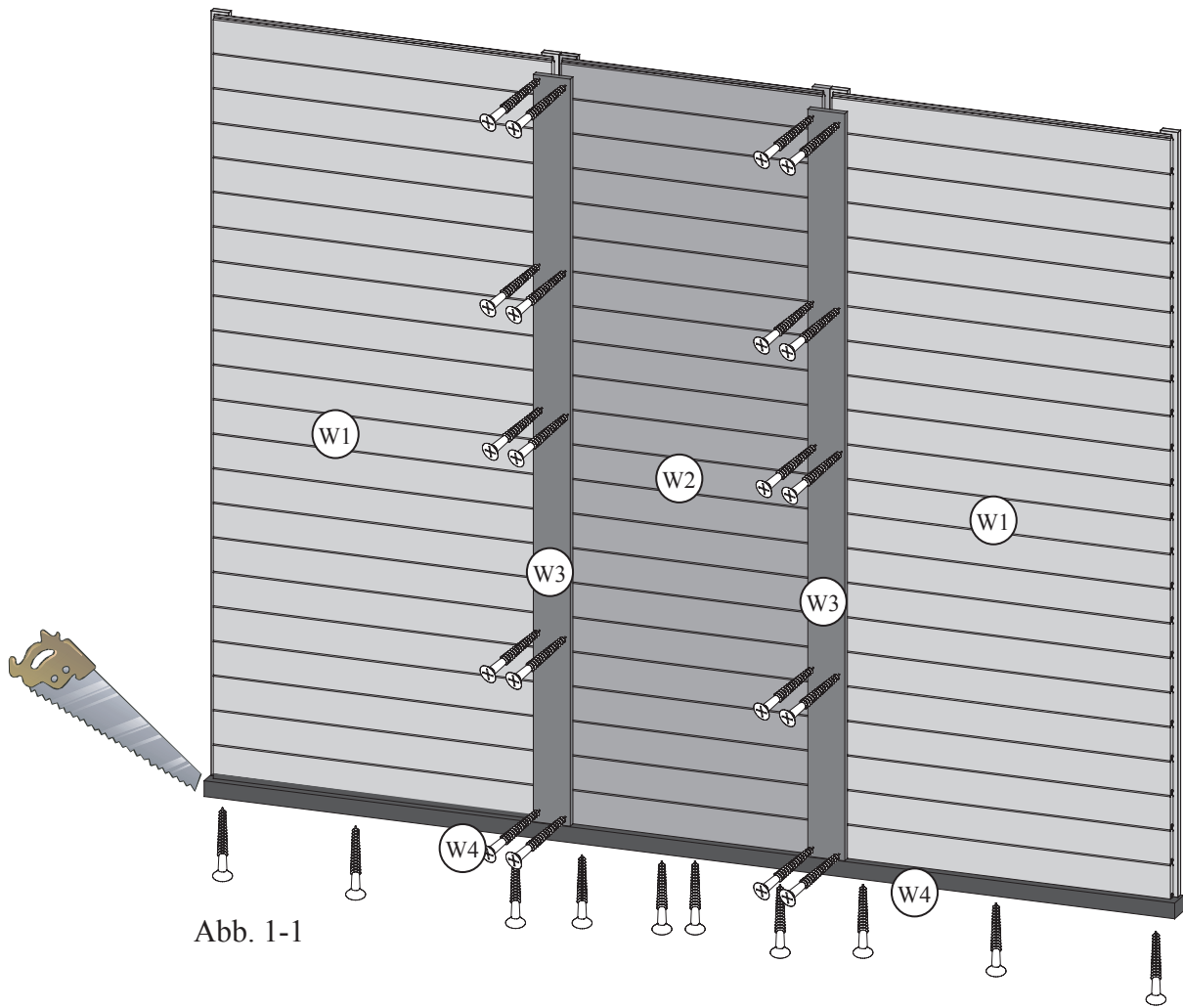

Abb.2-1

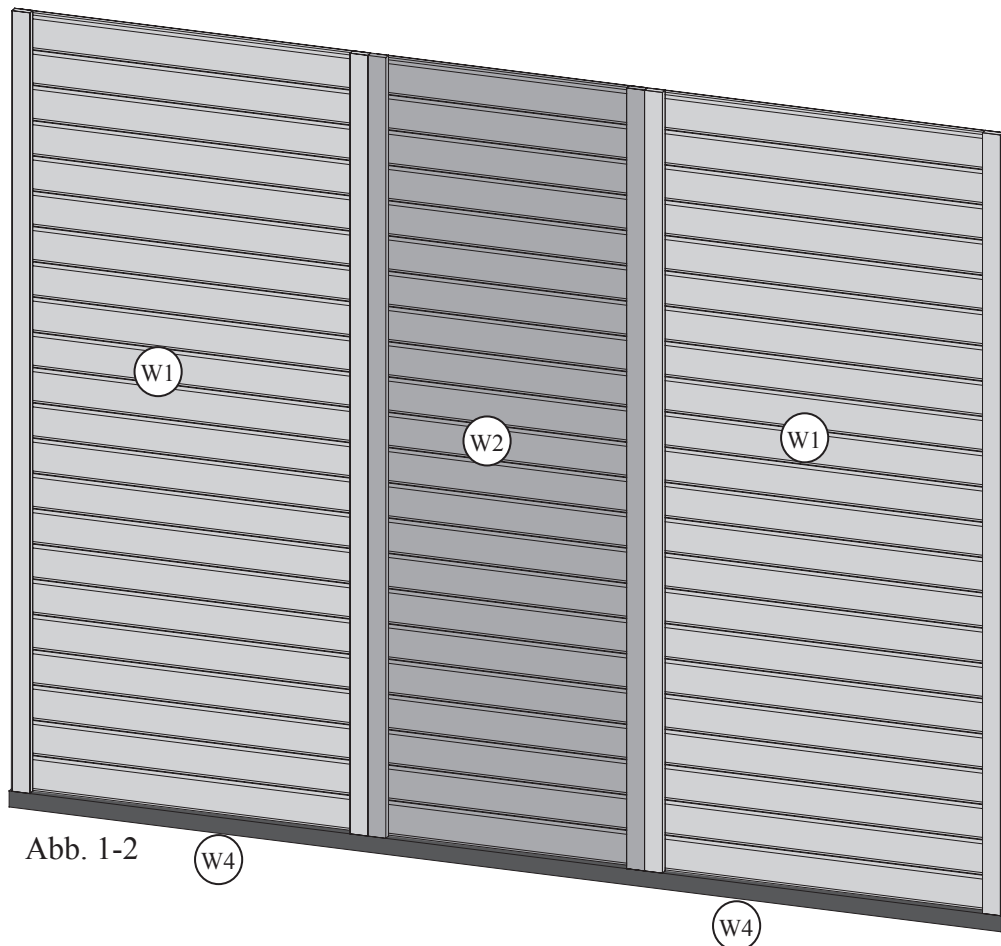

Abb. 2-2

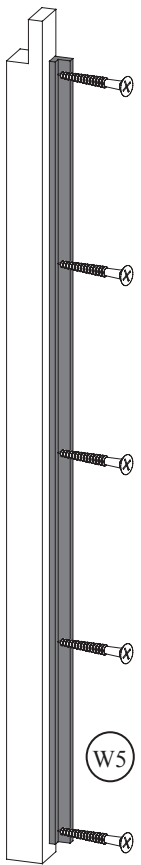

Abb. 3-1

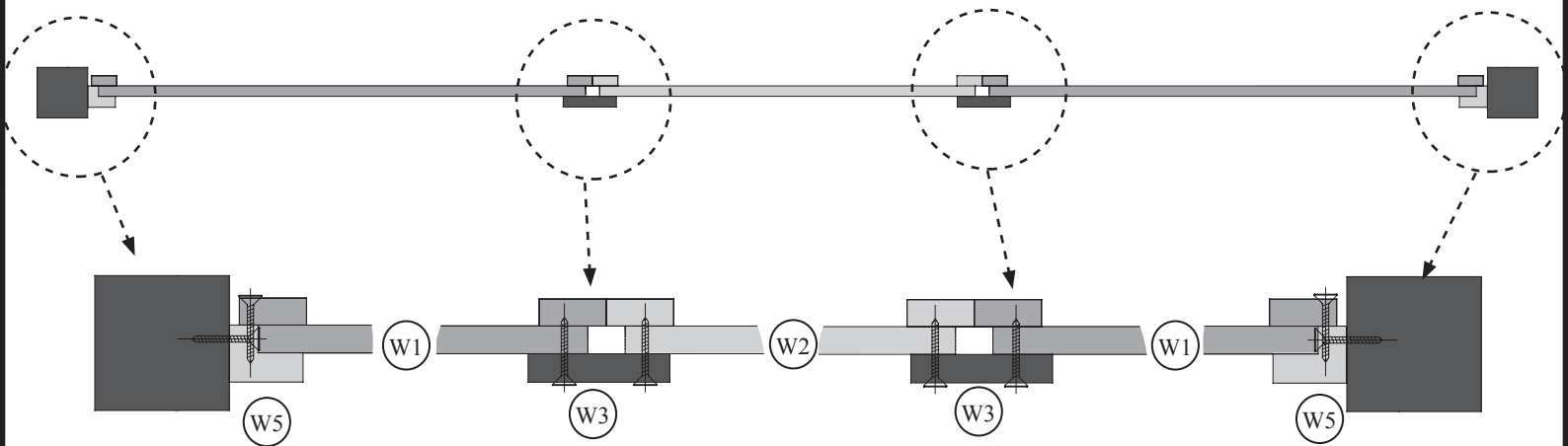
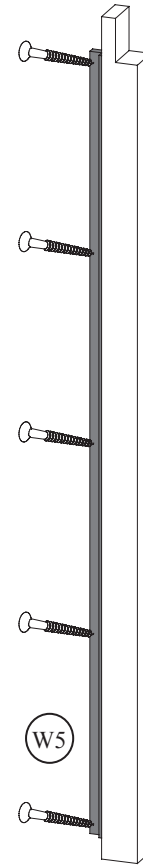

Abb. 3-2

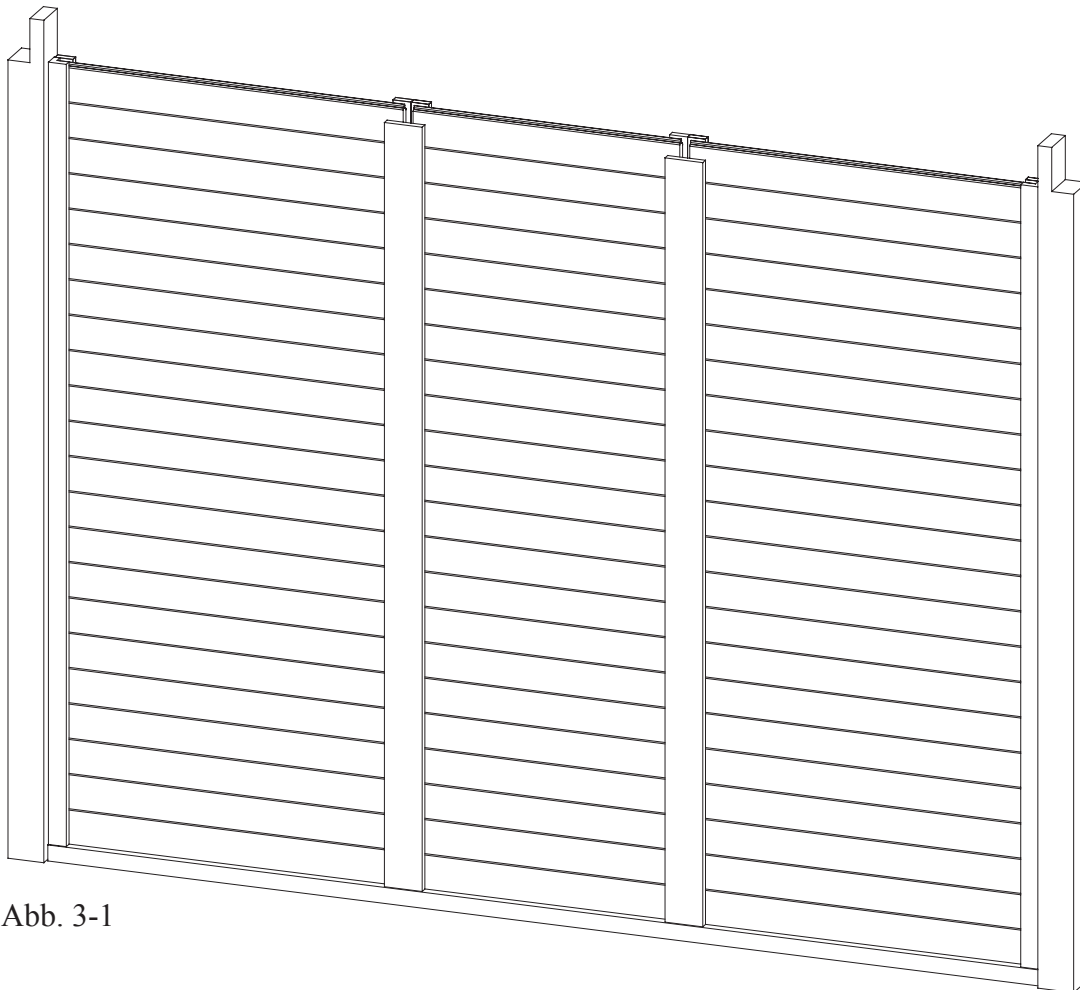

Abb. 4-1

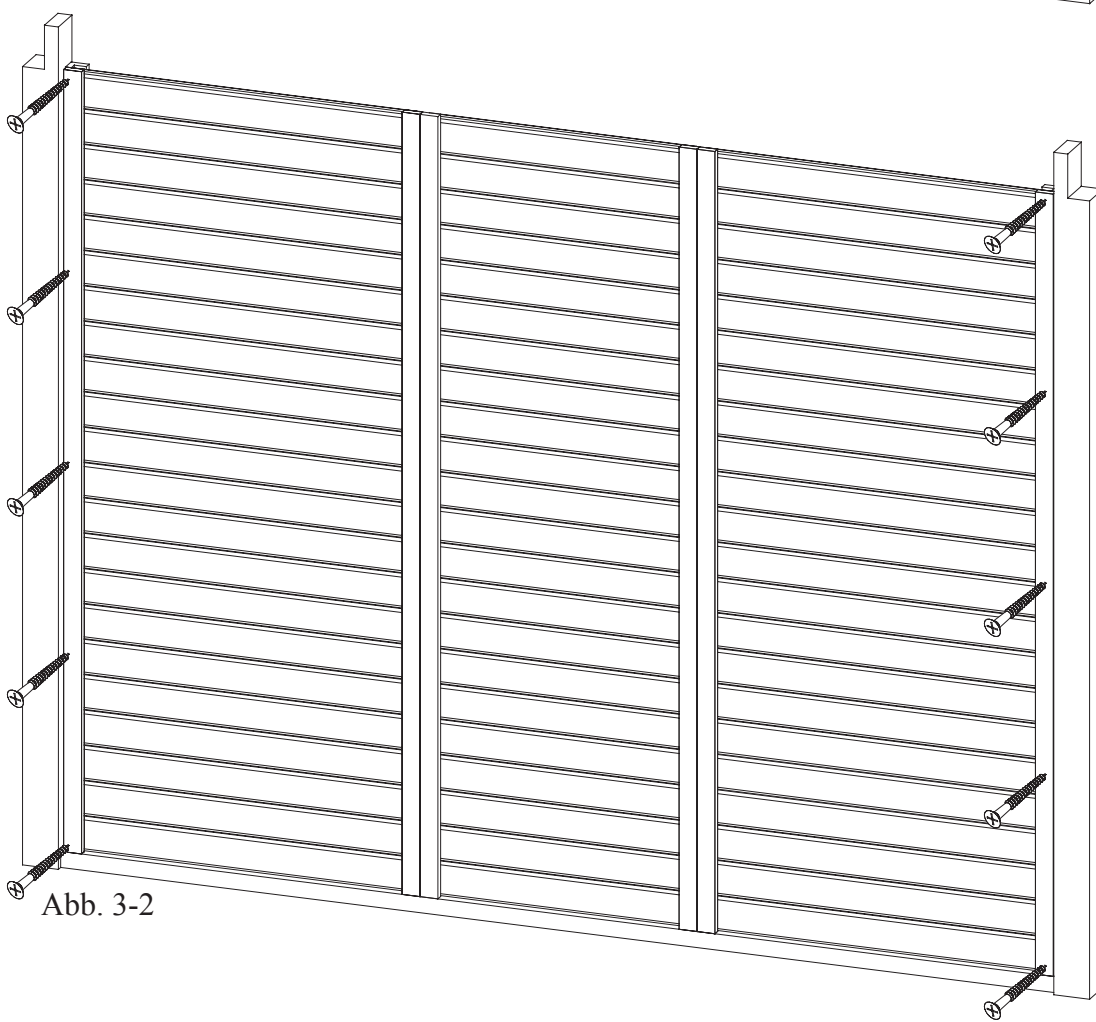
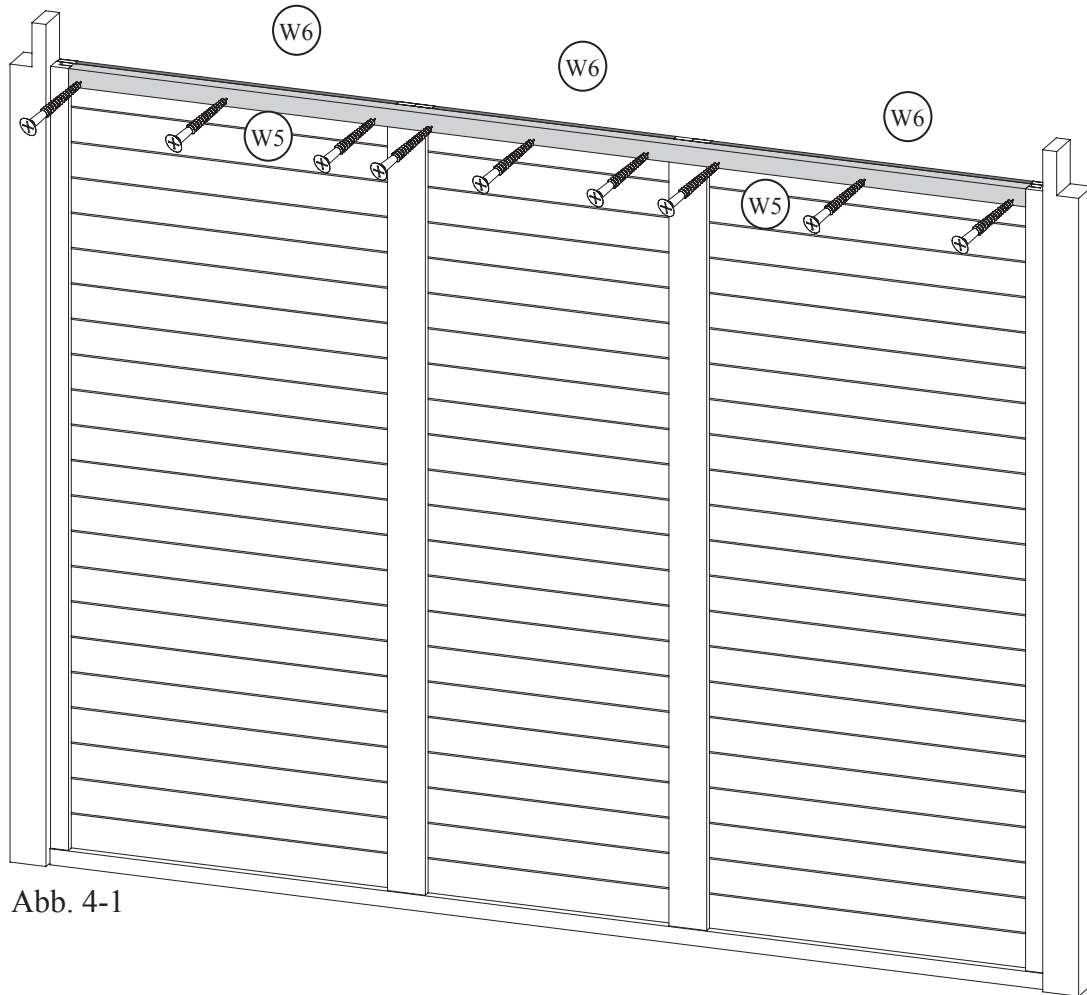
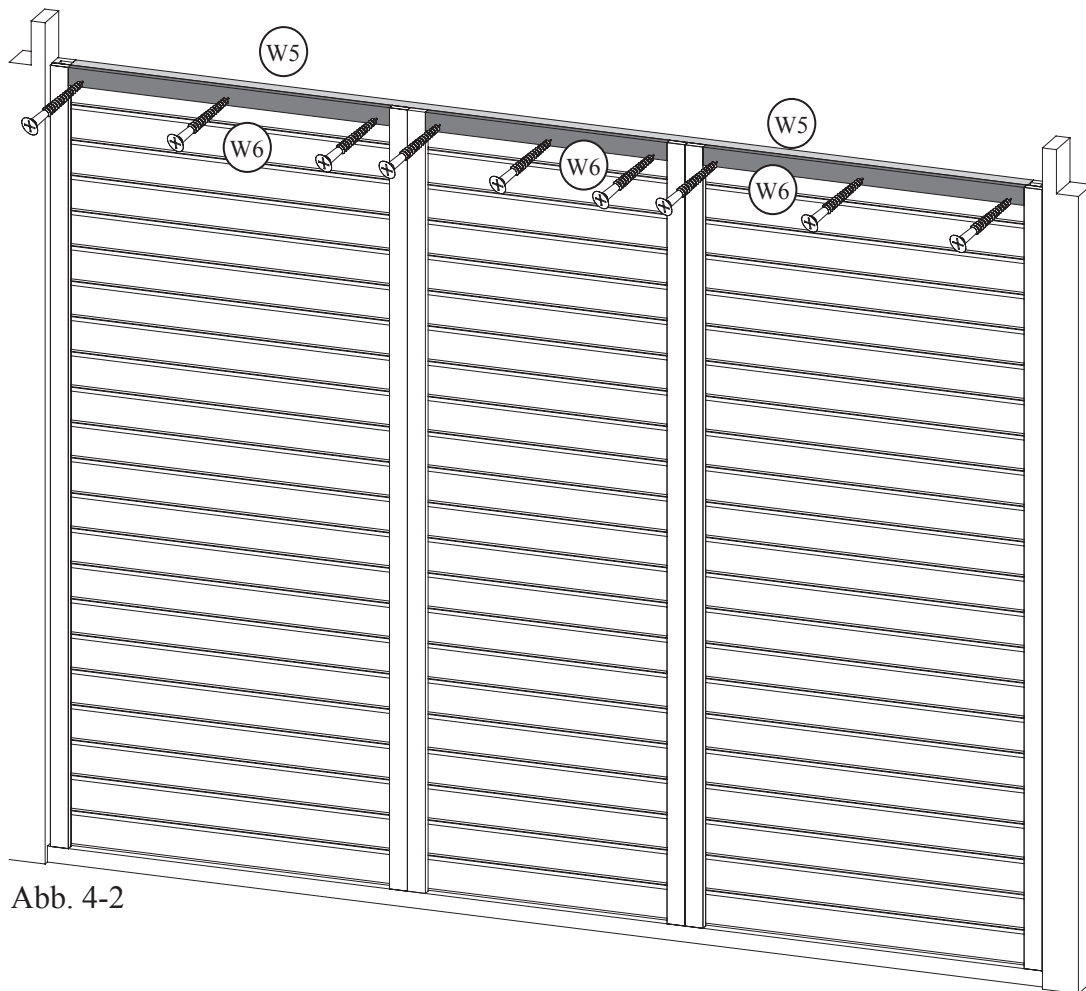

Abb. 4-2